



Submittal Data Sheet: WMMS-12EU-V2B(59)2

INDOOR UNIT



WMMS-12EU-V2B(59)2

ACCESSORIES

- ADVANCED HEALTHY KIT
HEPA/Enzyme/Cold Catalyst Filter
Anion Generator
- THERMOSTAT
- MOUNTING BRACKETS
- COPPER/WIRE/ACC.SET
- LINESET COVERS
- BRIDGE CONTROLLER

Model Number	WMMS-12EU-V2B(59)2	
Connection Pipes		
Outer Diameter Liquid Pipe	inches	1/4
Outer Diameter Gas Pipe	inches	3/8
Drain Hose Connection	inches	Ø 0.67

Dimensions & Weight Indoor Unit		
Dimension of Unit (W x H x D)	inches	48 x 27.6 x 8.9
Net /Gross Weight	lb	88 / 110

Job Name:		Tag #:	
Location		Date:	
Engineer:		Approval:	
Submitted to:		Unit #:	
Submitted by:		Drawing #:	
Reference		PO #:	

Ceiling/Wall/Floor Mount EU Unit

The EU indoor unit is the perfect solution for rooms of small and large sizes. 09K, 12K, 18K and 24K units are available. You can choose between a remote, individual wall thermostats or central control thermostat. Each unit has a digital display that easily shows all unit settings and provide technician information when necessary. EU units are efficient and quiet, and they can be installed on a ceiling, wall or floor.

Items	Unit / Conditions	WMMS-12EU-V2B(59)2
Power Supply	Voltage/Ph/Hz	208-230/1/60
	Allowed Voltage Range	187-253
Cooling Capacity	High / Med / Low	14100 / 11900 / 5900
	ID 70 / 60, OD 47 / 43 °F	13100
Heating Capacity	ID 70 / 60, OD 17 / 15 °F	11600
	ID 70 / 60, OD 17 / 5 °F	9100
SEER	Btu/h.W	16
HSPF	Btu/h.W	8.2
Dehumidifying Capacity	Pints/Hr.	2.96
Air Flow (CFM)	High / Medium / Low	383 / 324 / 265
Air-throw (Ft.)	Horizontal Installation	35-30 Upon Mounting Height / Speed / Temp.
	Upright Installation	35-20 Upon Mounting Location / Speed / Temp.
External Static Pressure	Water In.	0
Sound Level	Pressure dB(A) (H/M/L)	40/38/36
	Power dB(A) (H/M/L)	50/48/46
Fan Motor	Model	FG10A
	Shaft	Double
	Speed (RMP, H/M/L)	690 / 610 / 480
	Output (W)	15
	Input (W)	55
	Capacitor (uF)	1
Fan Wheel	Type-Piece	Centrifugal-2
	Diameter x Width (In.)	5.5 x 4.1
Swing/Step Motor	Model	MP35CB
	Piece	2
	Output (W)	2
Input Power of Ele. Heater	Type-W	NA
Electrical Protection Fuse	PCB/Transformer	T3.15A 250V / 0.2A
Evaporator Coil	Type	Alu. Fin/Inner Grooved Copper Tube
	Color	Blue
Copper Line Connections	Sealed by Dry Nitrogen	Yes
Drain Hose Connection	OD (In.)	Ø 0.67
Condensate Pump	Installed-Lift (In.)	NA
Refrigerant	Environmental Friendly	R410A
Filter	Type	Washable Particulate
	Size W x H (In.) - Qty.	21.8 x 8.68 - 2
Anti-Mildew Function		Yes
Pre-heating Function		Yes
Memory of Presets		Yes
Auto-Restart Function		Yes



INDOOR UNIT

Dimensions (inches)	
A	48"
B	27 19/32"
C	8 29/32"
D	11"
E	45 5/8"

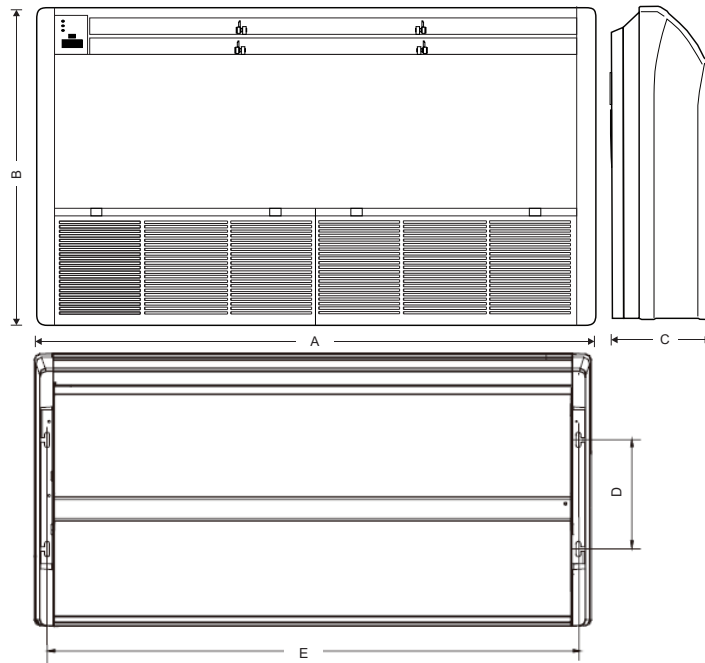

TERMINAL BLOCK

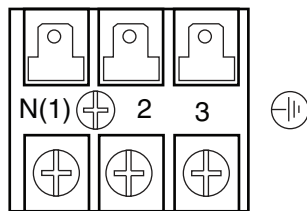

CLEARANCES

Floor Installation

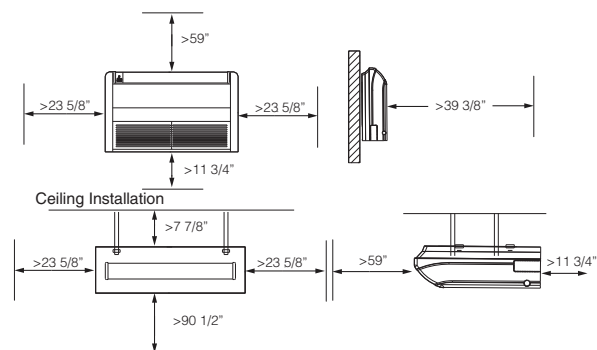

FEATURES

- 208-230/1/60 power input
- Quiet and efficient heating & cooling.
- LED display shows set temperature & operating modes.
- Motorized louver system quietly distributes air evenly
- "U-TOUCH" Remote Control.
- DC Inverter technology
- Stylish design
- Durable ABS molded cabinet
- Default flare brass connection valves
- Knock-outs for refrigerant pipes and wires
- Built to ETL/UL/CSA/ARI standards
- Easy installation and maintenance

YMGI Group
 601 Arrow Ln, O'Fallon, Missouri 63366
 Phone: 1-866-833-3138
 Fax: 1-866-377-3355
 ymgigroup.com

Sales Representative or Distributor: