



Submittal Data Sheet: VRFI-48UC-M2B(55)5

INDOOR UNIT



VRFI-48UC-M2B(55)5



Wall Controller Included

Job Name:		Tag #:	
Location		Date:	
General Contractor:		Mechanical Contractor:	
Sales Representative:		Sales Engineer:	
Submitted by:		Drawing #:	
Reference		PO #:	

Perfect for New Construction and Retrofits

Designed to replace existing air handlers. Easily adapts to your existing duct work. For new installations where ductwork is preferred. All electric heat pump replaces gas furnaces and AC coils to save energy and lower operation costs.

Install Horizontally or Vertically

UC Unit can be installed in a vertical or horizontal configuration, giving you the flexibility to install according to your desire or need. Because it can be horizontally mounted, it's a great solution for installations with minimum space, like an attic or crawl space.

Multiple Protections

Anti-freezing, temperature sensor malfunction, and fan motor overload protection.

Wall Mount Control

Wall Mount Control lets you adjust settings, and use a Remote Control.

Thermostat Controller

By using a YMGI bridge controller, North American style thermostats (Nest, Honeywell, Pro1, YMGI etc.) can be used for temperature control, locally or remotely, individually or in groups.

ACCESSORIES

- REPLACEMENT FILTERS
- THERMOSTAT
- COPPER/WIRE/ACC.SET
- BRIDGE CONTROLLER

Item	VRFI-48UC-M2B(55)5	
Connection Pipes		
Liquid/Gas Pipe Size	in.	3/8+5/8"
Drain Pipes Outer Diameter	in.	1"
Drain Pipes Thickness	in.	5/128
Dimensions & Weight Indoor Unit		
Unit Dimensions W x D x H	in.	24 3/4 x 21 1/4 x 48 1/4
Weight Net / Gross	lbs.	179 / 192

Item	Units	VRFI-48UC-M2B(55)5
Cooling Capacity	Btu/h	48,000
Heating Capacity	Btu/h	54,000
Air Flow H/M/L	CFM	1618 / 1500 / 1353
ESP H / L	In. WC	0.32 / 0.2
Sound Pressure Level H / M / L	dB	51 / 49 / 47
Sound Power Level H / M / L	dB	61 / 59 / 57
Rated Power	V/Ph/Hz	208-230/1/60
Circuit Breaker	Amp.	15
Fan Motor Power Output	W	428.7
Fan Motor Running Current	Amp.	3.4
Fan Motor Model	-	FGZ750B
Fan Type	-	Centrifugal
Fan Diameter-Height	Inch	10.24-9.69
Refrigerant	-	R410A
Evaporator Max. Allowable Pressure	PSI	600
Standard Controller	-	XK100
Connection Type	-	Brazing



Submittal Data Sheet: VRFI-48UC-M2B(55)5

INDOOR UNIT

Dimensions (inches)	
W	24 7/8"
H	48 1/4"
D	21 1/4"
A	11 5/8"
B	20"

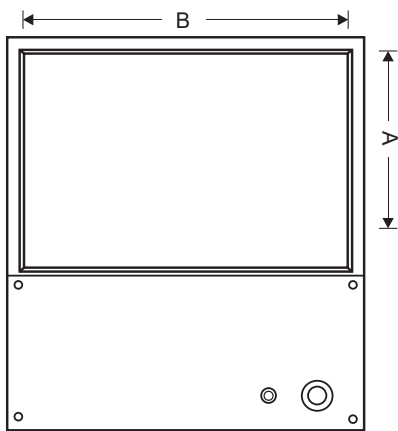

TOP

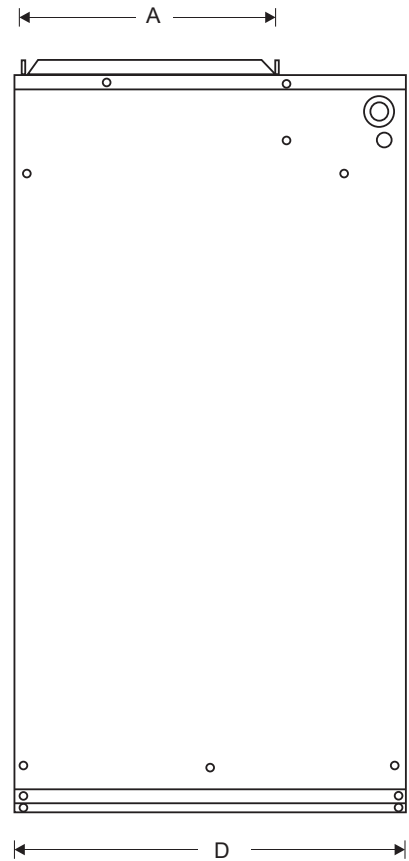
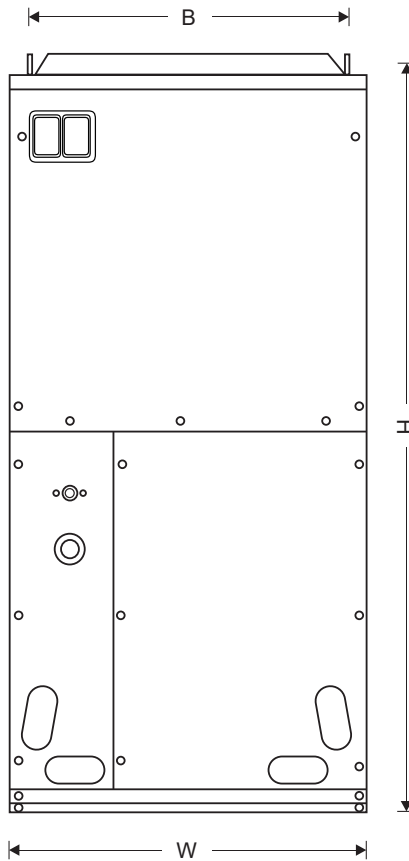

WIRING

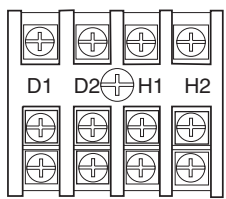

IDU/ODU Communication
D1 D2 Wired Controller
H1 H2

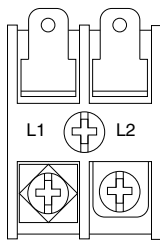

208-230/1/60

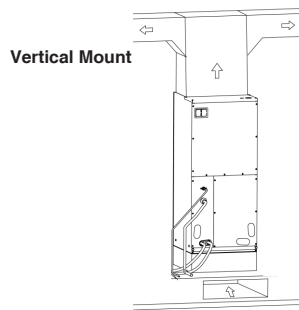

Vertical Mount

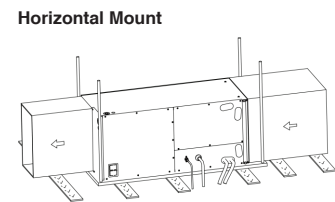

Horizontal Mount

FEATURES

- 208-230/1/60 power input
- Quiet and efficient heating & cooling.
- Durable powder coated cabinet
- Standard braze connections
- Knock-outs for refrigerant pipes and wires
- Built to ETL/UL/CSA/AHRI standards
- Easy installation and maintenance

- 4 Operating modes:
Cooling, Heating, Fan and Auto
- DC Inverter technology saves energy
- Memory stores set temperature and operating modes
- Can run at medium and low static pressure
- Optional ambient temperature sensor
- Built-in electronic expansion valve
- Built in timer

YMGI Group

601 Arrow Ln, O'Fallon, Missouri 63366
 Phone: 1-866-833-3138
 Fax: 1-866-377-3355
 ymgigroup.com
 sales@ymgigroup.com

Sales Representative or Distributor: