



Submittal Data Sheet: WMMS-18KC-V2B(58)4

INDOOR UNIT



WMMS-18EC-V2B(58)4

OUTDOOR UNIT



WMMS-18C-V2B(58)4

ACCESSORIES

- THERMOSTAT
- MOUNTING BRACKETS
- FOOT RISERS
- COPPER/WIRE/ACC.SET
- LINESET COVERS
- WINTER WIND BAFFLE
- BRIDGE CONTROLLER

Indoor Unit			WMMS-18EF-V2B(58)4
Dimensions (W x D x H)	Outline	in.	40 3/4" x 28 3/8" x 10 3/8"
	Package	in.	44 1/4" x 31 3/8" x 12 3/4"
Weight Net/Gross	lbs		72.8 / 83.79
Panel			
Dimensions (W x D x H)	Outline	in.	-
	Package	in.	-
Weight Net/Gross	lbs		-
Outdoor Unit			WMMS-18C-V2B(58)4
Dimensions (W x D x H)	Outline	in.	37 5/8" x 15 1/2" x 27 1/2"
	Package	in.	40 1/2" x 18" x 29 1/2"
Weight Net/Gross	lbs		105.8 / 114.7
Connection Pipe			
Outer Diameter	Liquid	in.	1/4"
	Gas	in.	1/2"

Job Name:		Tag #:	
Location		Date:	
General Contractor:		Mechanical Contractor:	
Sales Representative:		Sales Engineer:	
Submitted by:		Drawing #:	
Reference		PO #:	

YMGI's ductless Ceiling Cassette Mini Split (WMMS) is designed for high performance, easy installation and servicing. The single-zone WMMS system consists of 1 ceiling cassette indoor unit and 1 outdoor unit. The outdoor unit is designed for horizontal venting, making condenser installation in tight areas simple. Ideal for multi-family and high-rise buildings in residential, commercial, institutional, and industrial applications. Includes U-Touch remote control.

Model	System		WMMS-18KC-V2B(58)4	
	Indoor Unit		WMMS-18EC-V2B(58)4	
Capacity	Cooling	W	5000	
		Btu/h	17100	
	Heating	W	5400	
		Btu/h	18400	
EER/COP		-	2.94/2.70	
Power Supply		V/Ph/Hz	208-230/1/60	
Power Input	Cooling	W	1700	
	Heating	W	2000	
Current Input	Cooling	A	8.70	
	Heating	A	8.70	
Refrigerant Charge Volume		kg/oz	1.4/49.4	
Indoor Unit	Air Flow Volume	CFM	445	
		m3/h	760	
	ESP	Rated	In.wg	0
		Range	In.wg	0
Sound Pressure Level (L/M/H)		dB(A)	37 / 44 / 46	
Connection Pipe	Outer Diameter	Liquid	in.	1/4"
		Gas	in.	1/2"
	Max. Distance	Height	ft.	49 1/4
		Length	ft.	164 1/16
Model	Outdoor Unit		WMMS-18C-V2B(58)4	
Compressor Type			DC Inverter Driven Rotary	
Compressor RLA		A	12.0	
Fan Motor Power Output		HP	1/6	
Fan Motor FLA		A	1.5	
Max. Over Current Protection		A	25	
Min. Current (MCA)		A	17.0	
Outdoor Unit Air Flow Volume		CFM	2590	
Condenser Fin / Tube Structure			Aluminum Fin-copper Tube	
Maximum Allowable Pressure		PSIG	624	
Throttling Method			Electron expansion valve	
Defrosting Method			Automatic Defrosting	
Sound Pressure / Power Level		dB (A)	56 / 56	
Cooling Operation Ambient Temp. Range		°F	0 ~ 118	
Heating Operation Ambient Temp. Range		°F	0 ~ 75	
R410A Refrigerant Factory Charge		ozs	49.6	
Factory Charge for Pipe Length		ft.	25	
Gas Additional Charge		oz/ft.	0.3	



OUTDOOR UNIT

Dimensions (inches)	
W	37 5/8"
H	27 1/2"
D	15 1/2"

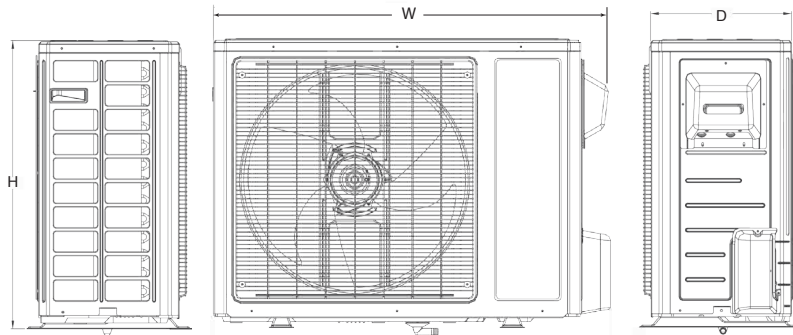
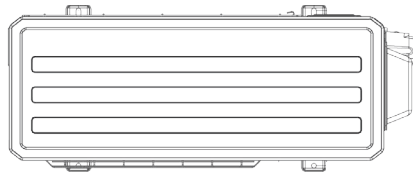

CLEARANCES

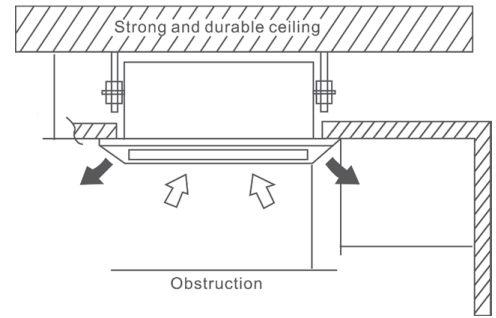

TERMINAL BLOCK

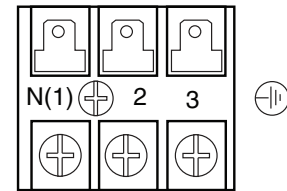

INDOOR UNIT

Dimensions (inches)	
A	26.38"
B	23.5"
C	23.25"
D	22.625"
E	5.75"
F	9.5"
G	23.125"
H	9.25"
I	22.625"
J	19.875"

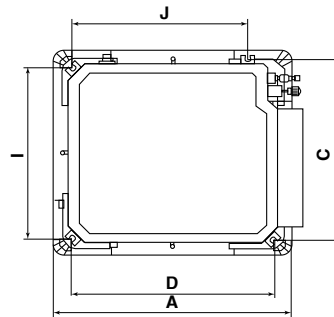
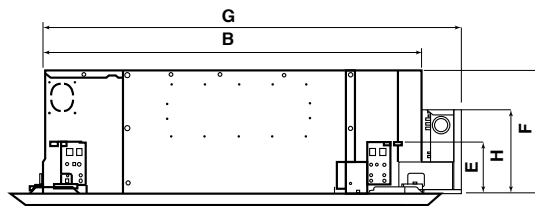

COOLING PERFORMANCE

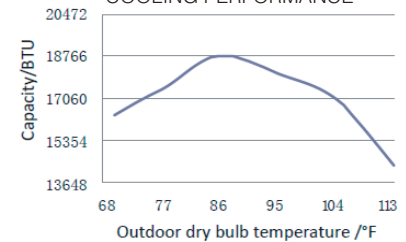

HEATING PERFORMANCE

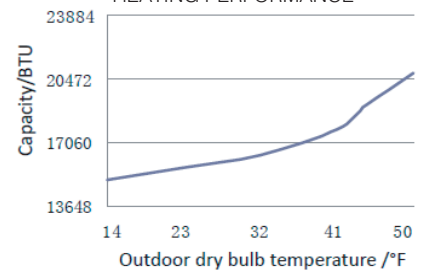

FEATURES

- 208-230/1/60 power input
- Quiet and efficient heating & cooling.
- LED display shows set temperature & operating modes.
- 4-way discharge fan.
- "U-TOUCH" Remote Control.
- DC Inverter technology
- Wide working ambient temperature ranges
- Stylish design
- Compact outdoor unit with side discharge
- Outdoor unit ships pre-charged.
- World-class quality compressors
- Durable powder coated cabinet
- Default flare brass connection valves
- Knock-outs for refrigerant pipes and wires
- Built to ETL/UL/CSA/ARI standards
- Easy installation and maintenance

YMGI Group
 601 Arrow Ln, O'Fallon, Missouri 63366
 Phone: 1-866-833-3138
 Fax: 1-866-377-3355
 ymgigroup.com

Sales Representative or Distributor: