



Submittal Data Sheet: VRFI-18EF-H2B(55)5

INDOOR UNIT



VRFI-18EF-H2B(55)5



Wall Controller Included

ACCESSORIES

- COPPER LINE SET
- LINE SET COVERS
- YMGI BRIDGE CONTROLLER
- THERMOSTAT

Job Name:		Tag #:	
Location		Date:	
General Contractor:		Mechanical Contractor:	
Sales Representative:		Sales Engineer:	
Submitted by:		Drawing #:	
Reference		PO #:	

Intelligent Drainage Device

Built-in water lift condensate pump and overflow protection.

Easy Installation

Dual air connections on the bottom and rear for flexible connections.

Convenient Maintenance

Tab type washable filter, detachable fan motor, independent water pump and electric box assemblies for easy maintenance.

Protection Functions

Built-in water overflow, anti-freezing, fan motor overload, and temperature sensor malfunction protection.

Digital Display

Users and service technicians can use the digital display on the Wall Mount Controller to see status and any protection or error codes.

Thermostat Controller

By using a YMGI bridge controller, North American style thermostats (Nest, Honeywell, Pro1, YMGI etc.) can be used for temperature control, locally or remotely, individually or in groups.

Model	VRFI-18EF-H2B(55)5	
Connection Pipes		
Liquid Connecting Pipe Diameter	in.	Ø3/8
Gas Connecting Pipe Diameter	in.	Ø5/8
Drain Pipe External Diameter	in.	Ø1
Drain Pipe Internal Diameter	in.	Ø13/16

Dimensions & Weight Indoor Unit		
Unit Dimensions (W x D x H)	in.	39 3/8 x 27 1/2 x 11 3/4
Net Weight	lbs.	94

Model	VRFI-18EF-H2B(55)5	
Cooling Capacity	Btu/h	18000
Heating Capacity	Btu/h	20000
Power Supply	V/Ø/Hz	208 ~ 230 / 1 / 60
Fan Motor Power Output	W	120
Airflow Volume (H/M/L)	CFM	411 / 470 / 588
Related Current Heating / Cooling	Amp	0.7
MCA	Amp	1.2
MOP	Amp	15
ESP	Std.	WG 0.36"
	Min.-Max.	WG 0 - 0.8"
Condensate Pump Lift from base of unit	in.	39 3/8"
Sound Pressure Level (H / M / L)	dB(A)	35 / 38 / 42
Refrigerant		R410A



Submittal Data Sheet: VRFI-18EF-H2B(55)5

INDOOR UNIT

Dimensions	
	inches
A	41"
B	19-3/4"
C	44 1/2"
D	11 7/8"
E	29 3/4"
F	39 3/8"
G	27 5/8"

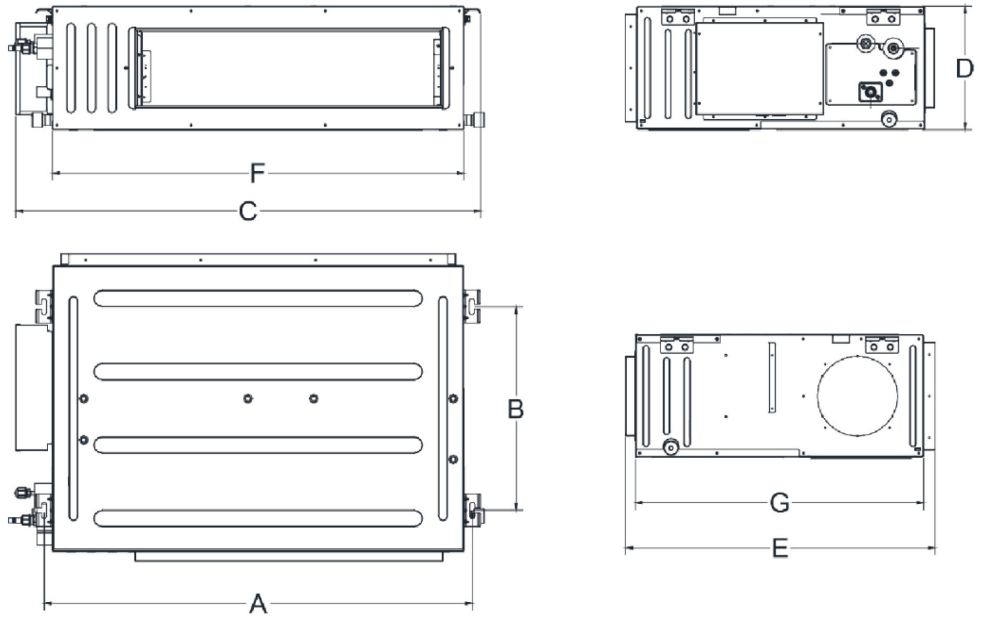

CLEARANCE

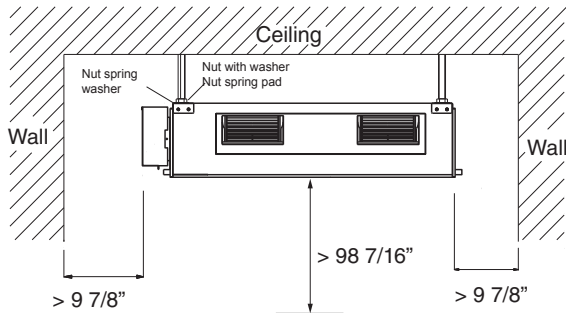

WIRING

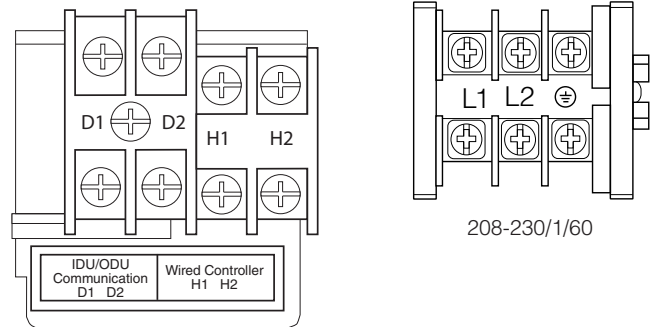

FEATURES

- 208-230/1/60 power input
- Quiet and efficient heating & cooling.
- Built-in Protection Functions
- Digital Wall Controller
- Can be controlled with a standard Thermostat by using optional YMGI Bridge Controller
- Pre-charged with dry nitrogen
- Standard flare nut connection
- Built to ETL/UL/CSA/AHRI standards
- Bolts on to existing ductwork
- Easy installation and convenient maintenance

YMGI Group
 601 Arrow Ln, O'Fallon, Missouri 63366
 Phone: 1-866-833-3138
 Fax: 1-866-377-3355
 ymgigroup.com

Sales Representative or Distributor: