



Submittal Data Sheet: VRFI-48EF-H2B(55)5

INDOOR UNIT



VRFI-48EF-H2B(55)5



Wall Controller Included

ACCESSORIES

- COPPER/WIRE/ACC.SET
- DUCT CONNECTOR FLANGE-RA
- DUCT CONNECTOR FLANGE-DA

Job Name:		Tag #:	
Location		Date:	
General Contractor:		Mechanical Contractor:	
Sales Representative:		Sales Engineer:	
Submitted by:		Drawing #:	
Reference		PO #:	

Medium / High Static Pressure Design

ESP can be up to 200 Pa (.08 WC) for central and zoned duct work in light commercial and other applications.

Convenient Maintenance

Convenient service port for easy maintenance.

Easy Installation

Easily mount unit from joists or ceilings with threaded rods through four mounting slots.

Protection Functions

Built-in anti-freezing, fan motor overload, and temperature sensor malfunction protection.

Digital Display

Users and service technicians can use the digital display on the Wall Mount Controller to see status and error codes.

Thermostat Controller

By using a YMGI bridge controller, North American style thermostats (Nest, Honeywell, Pro1, YMGI etc.) can be used for temperature control, locally or remotely, individually or in groups.

Model	VRFI-48EF-H2B(55)5	
Connection Pipes		
Liquid Connecting Pipe Diameter	in.	Ø3/8
Gas Connecting Pipe Diameter	in.	Ø5/8
Drain Pipe External Diameter	in.	1 3/16
Drain Pipe Internal Diameter	in.	1 1/16
Dimensions & Weight Indoor Unit		
Dimensions (W x D x H)	in.	55 1/8 x 27 1/2 x 11 3/4
Net Weight	lbs.	119

Model	VRFI-48EF-H2B(55)5		
Cooling Capacity	Btu/h	48000	
Heating Capacity	Btu/h	54000	
Power Supply	V/Ø/Hz	208~230 / 1 / 60	
Fan Motor Power Output	W	320	
Airflow Volume (High / Medium / Low)	m³/h	1650/1900/2350	
	CFM	971 / 1118 / 1383	
Related Current Heating / Cooling	Amp	1.3	
MCA	Amp	2.0	
MOP	Amp	15	
ESP	(std. 150)	Pa	0~200
	(std. .6")	WC	up to 0.8"
Sound Pressure Level (H / M / L)	dB(A)	41 / 43 / 46	
Refrigerant		R410A	



Submittal Data Sheet: VRFI-48EF-H2B(55)5

INDOOR UNIT

Dimensions (inches)	
A	56 3/4"
B	19 3/4"
C	62 1/4"
D	11 7/8"
E	29 3/4"
F	55 1/8"
G	27 5/8"

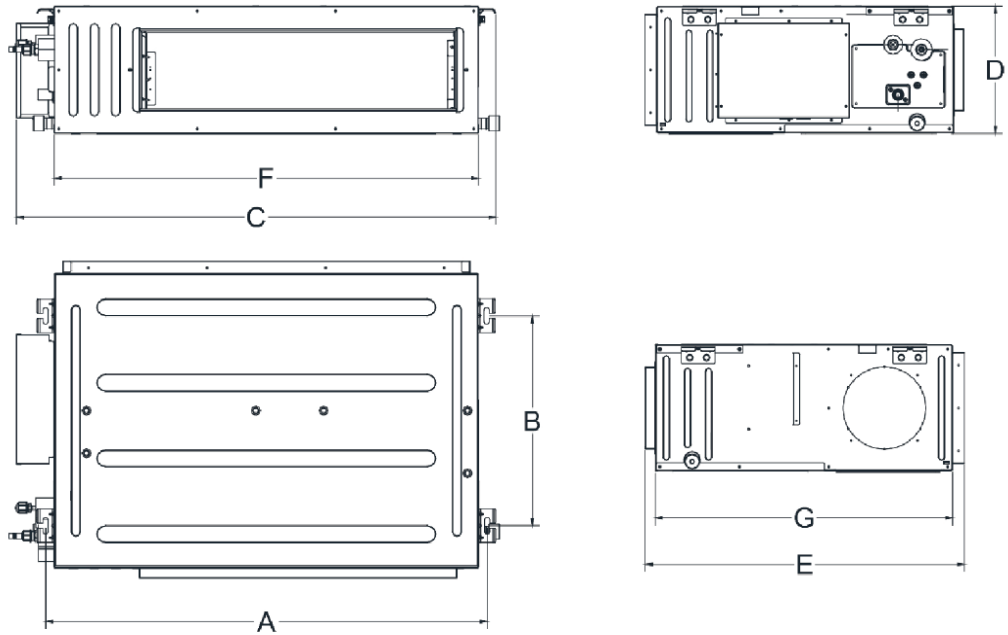

WIRING

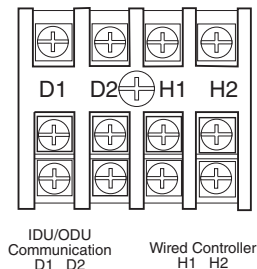
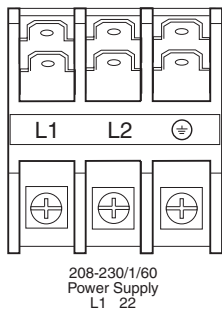

CLEARANCE

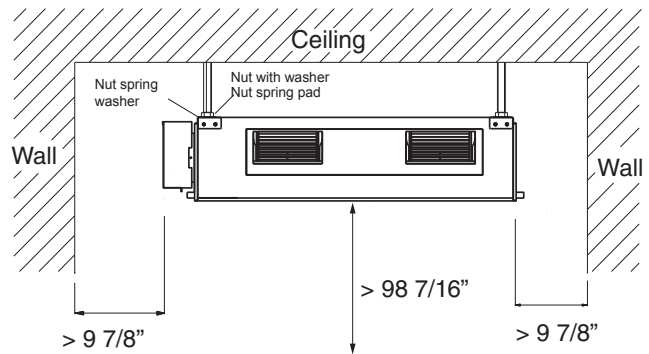

FEATURES

- Powerful fresh air handling
- 208-230/1/60 power input
- Quiet and efficient heating & cooling.
- Wide working ambient temperature ranges
- Compact design
- Unit ships pressurized with nitrogen.
- Two drain line connections
- Durable powder coated cabinet
- Standard flare brass connection valves
- Knock-outs for refrigerant pipes and wires
- Built to ETL/UL/CSA/AHRI standards
- Easy installation and maintenance

YMGI Group
601 Arrow Ln, O'Fallon, Missouri 63366
Phone: 1-866-833-3138
Fax: 1-866-377-3355
ymgigroup.com
sales@ymgigroup.com

Sales Representative or Distributor: