



YMGI, Engineered Comfort Products for A Sustainable  
and Efficient Green World!

## Quick Installation Manual

### G-Cloud Wi-Fi Controller



Thank you for choosing this YMGI product. Please read the owner's manual carefully before installation and operation, and retain for your records and future reference. If you need a replacement copy, please contact your local agent or visit [www.ymgigroup.com](http://www.ymgigroup.com) to download a current electronic version.

#### NOTICE

This product is designed and manufactured to be free from any defects in material and workmanship during normal use and maintenance. Installation, operation, maintenance and repair must follow all standards and professional practices for regular cooling and heating equipment, such as NEC, State, or Local Codes and all related documents/manuals provided by YMGI. Failure to follow and adhere to all codes and documentation can cause damage to equipment, property even personal injury.

**Installer:** Currently licensed/certified HVAC technicians only. Must Read the manual and all provided documents prior to installation. Complete and fill out all required information on the warranty registration card.

**User:** Retain this manual and all supplied documents for your records and future reference.

**Service:** Use this manual for information concerning servicing and maintenance of this product.

#### SAFETY WARNING

Only qualified technicians should install and service this equipment. The installation, startup, operation and servicing of this equipment can be hazardous and requires a HVAC professional who has been trained, licensed and certified. Installations, adjustments or any equipment alterations done by an unqualified person could result in serious injury and even death. When working on the equipment, observe all precautions in the provided documents, on the tags, stickers, and labels that are attached to or placed on the equipment.



## Contents

COMPONENT MAP ..... 1  
 PARTS LIST ..... 2  
 OPENING METHOD ..... 3  
 INSTALLATION ..... 4  
 APP DOWNLOAD ..... 7

## Preface

For correct installation and operation, please read all instructions carefully.

## WARNING

1. Please make sure the wiring method for power cord and communication wire is correct. Otherwise, the controller can't operate normally or even the controller will be damaged.
2. This product is related to heavy current. Prohibit knocking, throwing or disassembling the G-Cloud to avoid accident.
3. Do not operate this unit near to the equipment or the device which will transmit radio frequency. Because the radio frequency may damage the product.
4. Do not operate this unit at the place where will be affected by electromagnetism easily. Otherwise, the unit can't operate normally.

## User Notice

1. Once user has operated this product, it indicates that he has accepted this statement.
2. For operating this product correctly, please read this instruction manual carefully before operation and keep it well for future reference.
3. Pictures listed in this specification are just for explanatory illustration, final effect shall be subject to practical products.
4. Please ensure to use this product under friendly circumstance. Any products control failure or all other damages caused by hacker attack, governmental regulations and any other internet and communication wiring reasons or force majeure events, we shall not undertake any legal responsibilities.
5. Users acknowledged the efforts that we made in saving user data and providing protection to avoid being visited and disclosed without authorization.
6. Graphics in the instruction manual are for reference only.



## Component Map

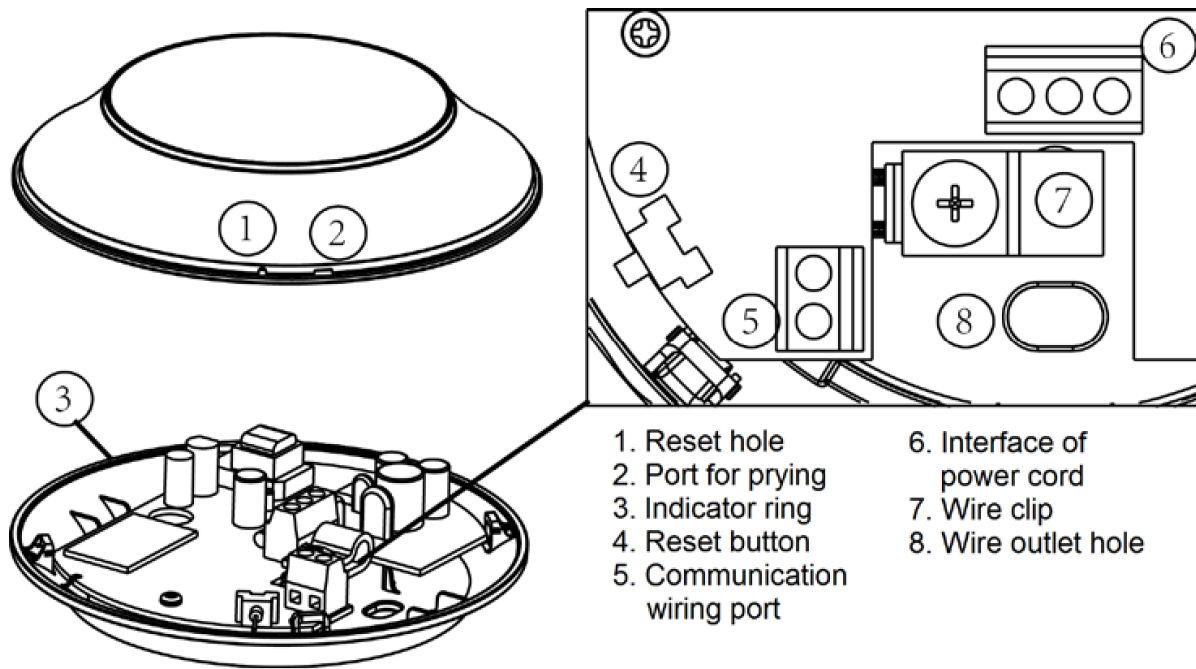



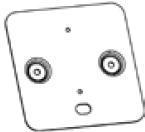





Fig.1

G-Cloud, operated with smart terminal, GREE+ App and a wireless router, can achieve long-distance monitoring, schedule management, scene management, device linkage and other functions to YMGI and Gree air conditioners.

## Parts List

Name	Figure	Quantity	Unit	Function
Wire clip		1	Piece	Fix power cord
Tapping screw		1	Piece	Fixing wire clip
Bolt sub-assembly MA×10		2	Set	Fixing the controller to the installation plate
Installation plate		1	Piece	Connecting controller with Wiring box
Cross-recessed pan head screw		2	Piece	Fix the installation plate to the Wiring box /fix the controller to the ceiling(aluminum)
Nut with washer		2	Piece	Fix the cross-recessed pan head screw on the ceiling(aluminum)
Plastic expansion tube		2	Piece	Fix ceiling(plaster) screw
Tapping screw		2	Piece	Fixing the controller to the ceiling(plaster/wood)

## Opening Method

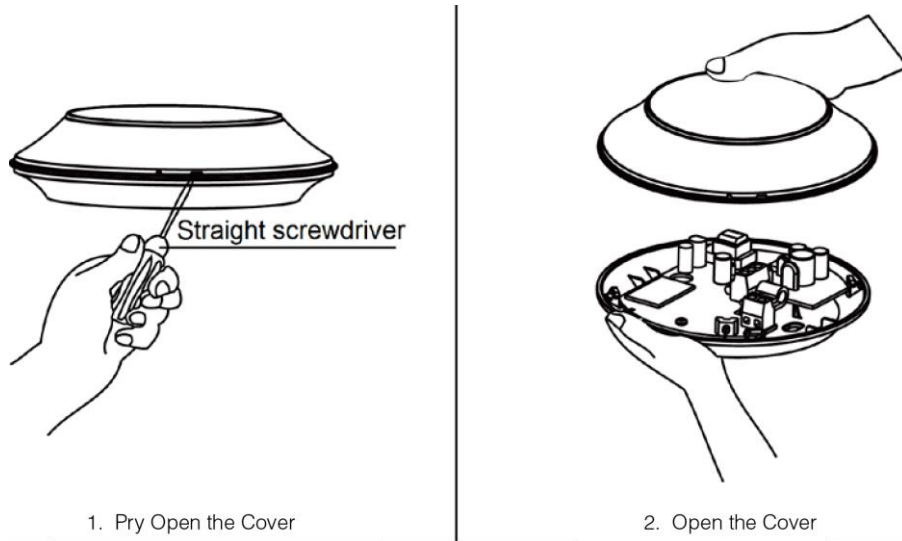

Fig.2

## Installation

### Note:

1. The controller can be connected with any indoor unit for installation.
2. Please install it in an indoor site with a strong Wi-Fi signal.

### Installation Method 1

#### Ceiling Installation

Please select installation way according to the material of ceiling (e.g. plaster, aluminum, and wood).

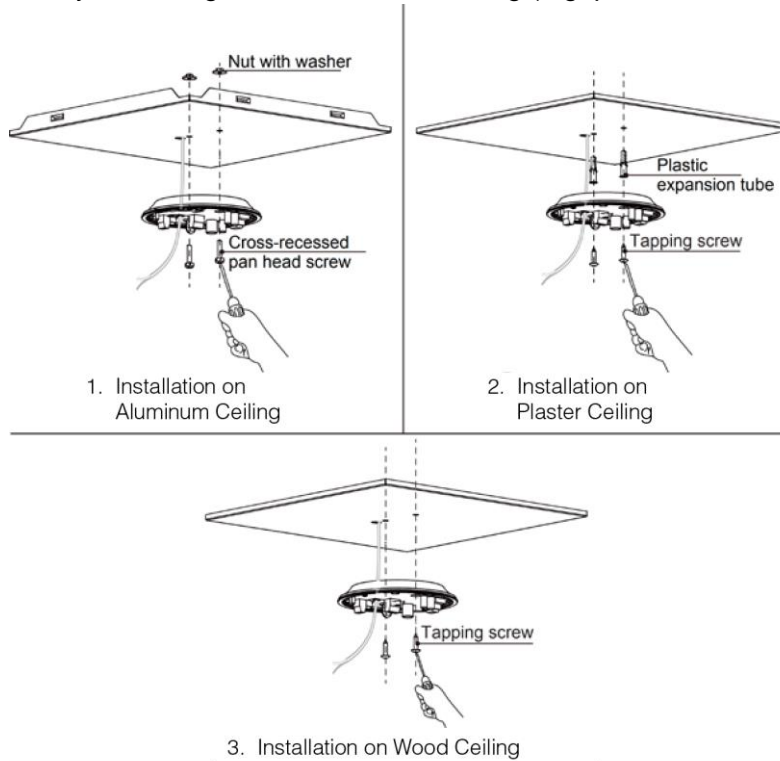

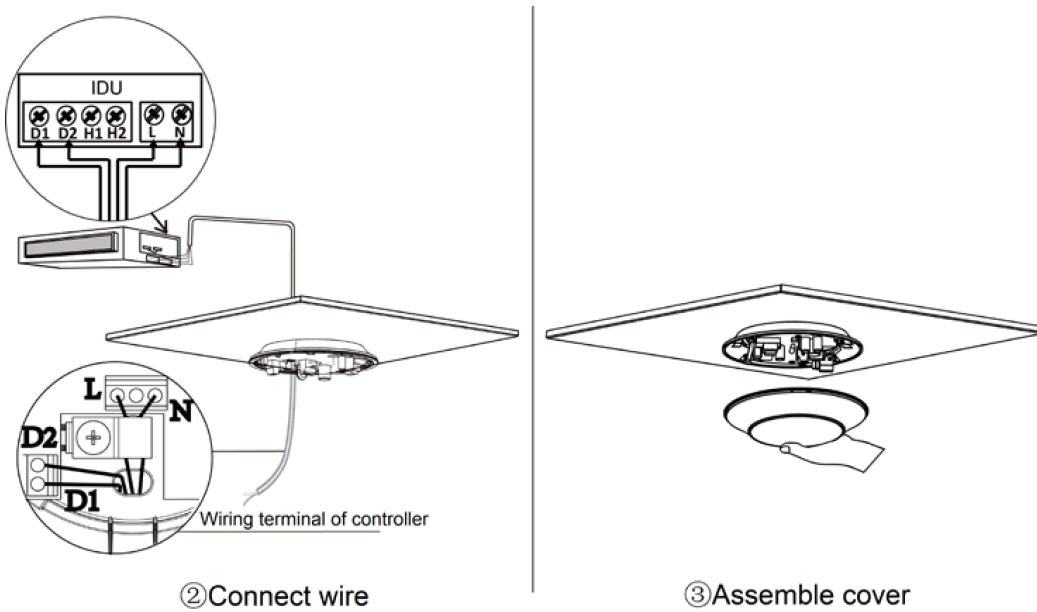

Fig.3

**1) Notes for connecting wire:**

To avoid losing of controller power cord in the wall, the controller power cord can be twisted with IDU power cord before connecting it to the wiring terminal.

Do NOT connect the controller power cord and IDU power cord to the same wiring terminal.

Suggested size of controller power cord: 0.5mm<sup>2</sup> - 1mm<sup>2</sup>.

D1 and D2 are the interfaces of communication cable (nonpolar) and L and N are the interfaces of AC 100V~240V/50Hz/60Hz~1Ph power cord.

**2) Notes for assembling cover**

When assembling the cover, fix the reset hole on the cover at the reset button on the controller, and then close the cover completely.

## Installation Method 2:

(2) Install it to the Wiring box.

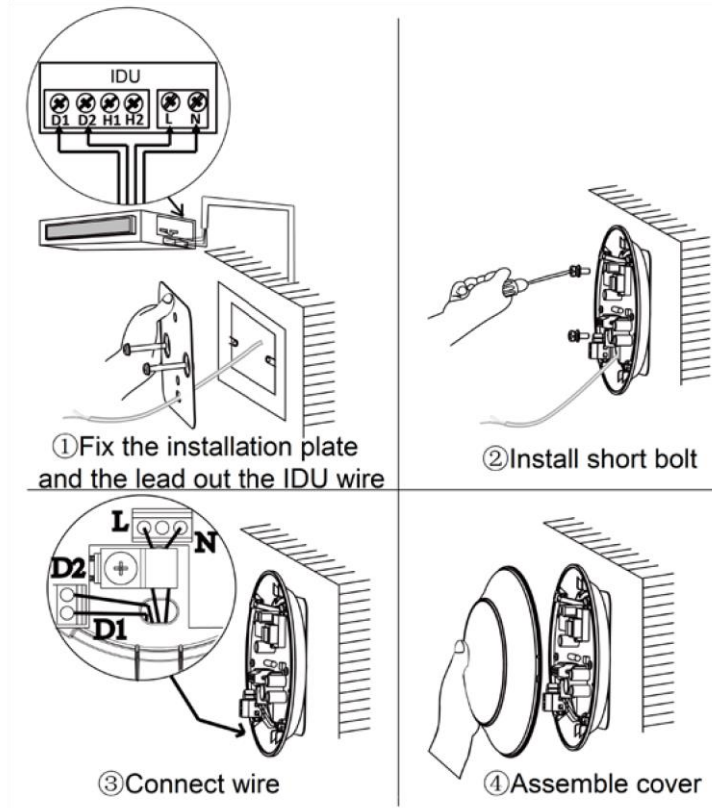

Fig.4

## App Download

1) Search “GREE+” in App store and download the App for installation.

**Note:**

- For Android system, the user can download “GREE+” App in Google Play Store. For iPhone, the user can download “GREE+” App in Apple Store.
- Android system users should download Google Play Store first. Otherwise the “GREE+” App cannot be downloaded.
- Supported system version: iOS6.0 system or higher version and Android 4.0 system or higher version.

## Quick Configuration:

The indicator of G-Cloud will blink once after energization, which indicates that it is working normally. During initial operation, the G-Cloud will by default be in configuration status. The indicator will blink after energizing for 8 seconds.

If not Press and Hold the “FUNCTION” button and “FAN” button of IDU wired controller simultaneously for 5 seconds (as shown in the illustration to the right).

When the wired controller displays “oC”, it means reset is complete. If not, you can press and hold the “RESET” button of G-Cloud for 5 seconds. When the indicator of controller blinks, it means reset is completed.

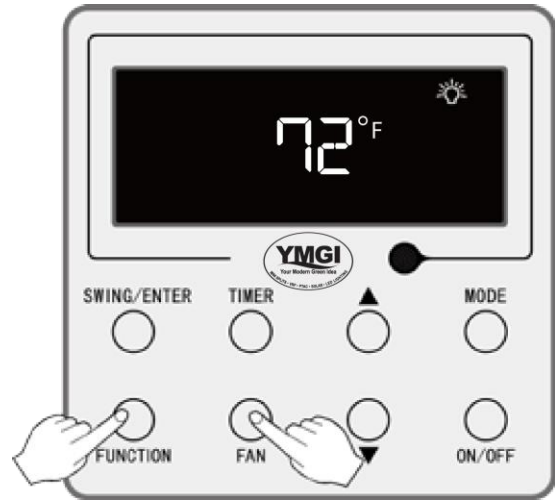

Connect your mobile with indoor Wi-Fi and then activate GREE+ App. Click at the top right corner of the homepage “Device” and then select “Add device”.

Wi-Fi network name will be displayed automatically in the configuration interface as shown in Fig.5. Input Wi-Fi password and then click “Configure” button. Quick configuration is as shown in Fig. 6.

When “Configuration is done” is shown in the configuration interface, the indicator will be off and configuration is done.

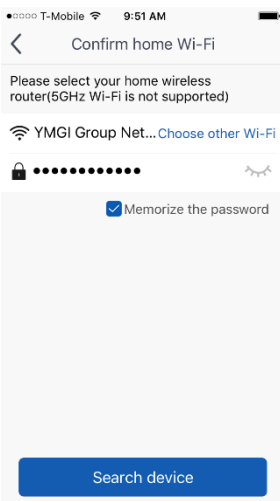

Fig.5

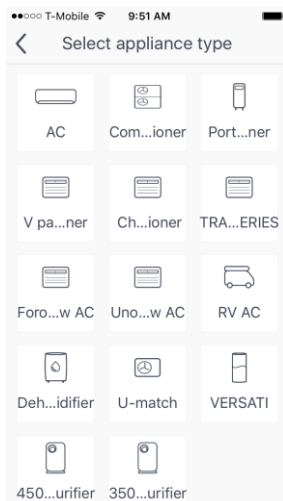
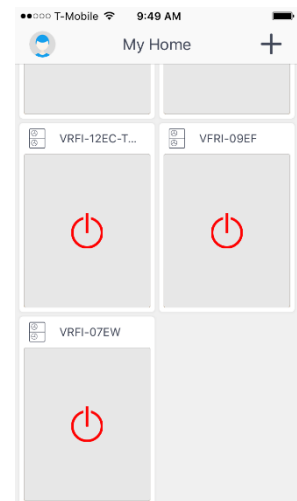

Fig. 6



### Note:

- If you replace the router or change the router name or password, you should reconfiguration the unit.
- If the wired controller cannot reset G-Cloud, press the Reset button of G-Cloud to reset it