



Submittal Data Sheet: WMMS-36K-U2B(58)4

HEATS DOWN TO -13°F

INDOOR UNIT



WMMS-36E-U2B(58)4

OUTDOOR UNIT



WMMS-36C-U2B(58)4

ACCESSORIES

- Built in Wi-Fi
- High Efficiency DC Inverter Technology
- Low Ambient Cooling down to -4°F (Range -4°F to 115°F)
- Low Ambient Heating down to -13°F (Range -13°F to 75°F)
- Quiet and Compact Design
- Wireless Remote with LCD Display
- Copper Tube / Aluminum Fin Coils on Indoor and Outdoor Units
- Wired Controller Options
- Blue Colored Fin - 500 Hrs Salt Spray Tested
- Composite Drain Pan

Job Name:		Tag #:	
Location		Date:	
General Contractor:		Mechanical Contractor:	
Sales Representative:		Sales Engineer:	
Submitted by:		Drawing #:	
Reference		PO #:	

YMGI's ductless Wall Mount Mini Split (WMMS) is designed for high performance, easy installation and servicing. The single-zone WMMS system consists of 1 wall-mounted indoor unit and 1 outdoor unit. The outdoor unit is designed for horizontal venting, making condenser installation in tight areas simple. Ideal for multi-family and high-rise buildings in residential, commercial, institutional, and industrial applications. Includes U-Touch remote control.

SPECIFICATIONS	WMMS-36E-U2B(58)4 / WMMS-36C-U2B(58)4		
System Type	HEAT PUMP		
SYSTEM PERFORMANCE			
Cooling			
Min - Max	Btu/h	7500 - 37200	
Capacity @95°F	Btu/h	33600	
Heating			
Min - Max	Btu/h	10200 - 38500	
Capacity @5°F	Btu/h		
Capacity @17°F	Btu/h	21000	
SEER2		20.0	
EER2		10.5	
HSPF2		8.5	
COP @5°F			
COP @47°F		3.2	
Cooling Temperature Range	°F	-4 - 115	
Heating Temperature Range	°F	-13 - 75	
Refrigerant	Type	R410A	
INDOOR UNIT		WMMS-36E-U2B(58)4	
Air flow (Min-Max)	CFM	471 - 912	
Sound Pressure Level (Min - Max)	dB(A)	37 - 56	
Dehumidification	pt/hr	7.40	
External Dimensions (WxHxD)	in	53-3/16 x 12-13/16 x 9-15/16	
Package Dimension (W x H x D)	in	56-3/4 x 16-5/8 x 14-1/2	
Net Weight	lbs	44.1	
Gross Weight	lbs	54.0	
OUTDOOR UNIT		WMMS-36C-U2B(58)4	
Compressor	Type	GREE G-10 / 2 - STAGE INVERTER	
Sound Pressure Level	dB(A)	62	
External Dimensions (W x H x D)	in	39-3/8 x 29-3/8 x 16-13/16	
Package Dimension (W x H x D)	in	42-9/16 x 31-15/16 x 19-1/16	
Net Weight	lbs	127.9	
Gross Weight	lbs	138.9	
ELECTRICAL			
Power Supply		208 - 230V / 1Ph /60Hz	
Voltage Range (Min - Max)	VAC	187 - 253	
Rated Current - Cooling	A	20	
Rated Current - Heating	A	18	
MCA	A	23	
MOCP	A	35	
Suggested Breaker Size	A	25	
Main Power Wire Size	AWG	Per Local Code	
Interconnecting Wire Size	AWG	14 / 4	

System	WMMS-36K-V2B(58)4	
REFRIGERANT PIPING		
Refrigerant Charge - R410A	oz	84.7
Additional Charge	oz/ft	0.5
Line Set Size (Liquid - Gas) - Flared Connections	in	1/4 - 5/8
Pre-Charge Length	ft.	25
Pipe Length (Min - Max)	ft.	10 - 82
Max. Pipe Elevation	ft.	33
INDOOR UNIT		WMMS-36E-U2B(58)4
External Dimensions (WxHxD)	in	53-3/16 x 12-13/16 x 9-15/16
Package Dimension (W x H x D)	in	56-3/4 x 16-5/8 x 14-1/2
Net Weight	lbs	44.1
Gross Weight	lbs	54.0
OUTDOOR UNIT		WMMS-36C-U2B(58)4
External Dimensions (W x H x D)	in	39-3/8 x 29-3/8 x 16-13/16
Package Dimension (W x H x D)	in	42-9/16 x 31-15/16 x 19-1/16
Net Weight	lbs	127.9
Gross Weight	lbs	138.9



OUTDOOR UNIT

Dimensions (inches)	
A	36-11/32
B	39-3/8
C	29-3/8
D	14-17/32
E	16-13/16
F	24-1/64
G	15-35/64

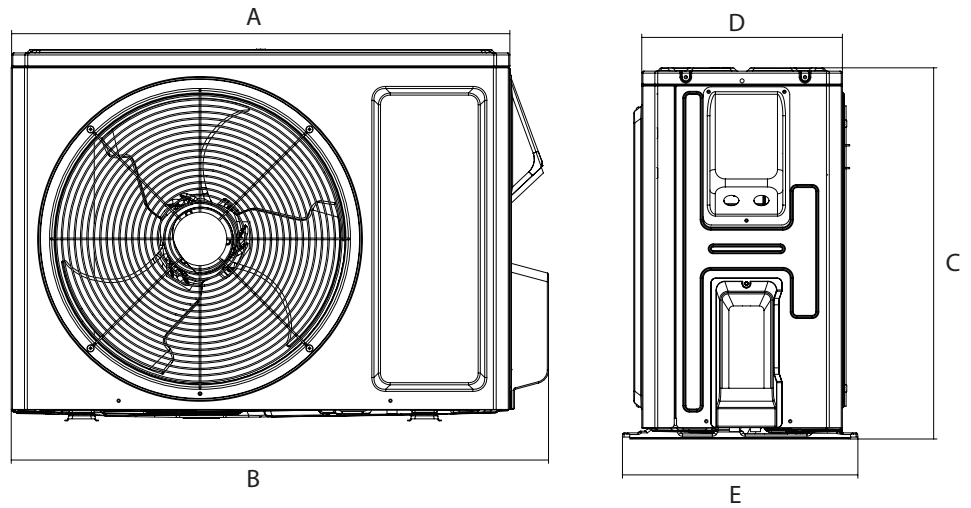

TERMINAL BLOCK

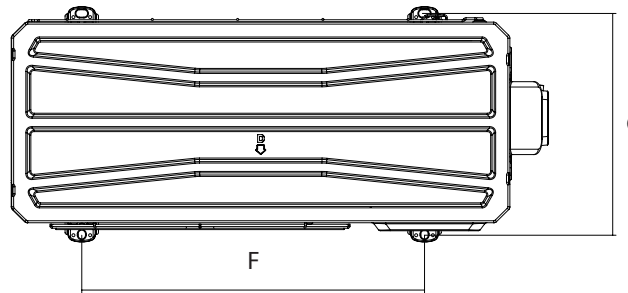
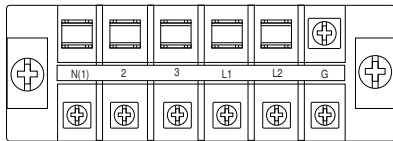

INDOOR UNIT

Dimensions (inches)	
W	53-3/16
H	12-13/16
D	9-15/16

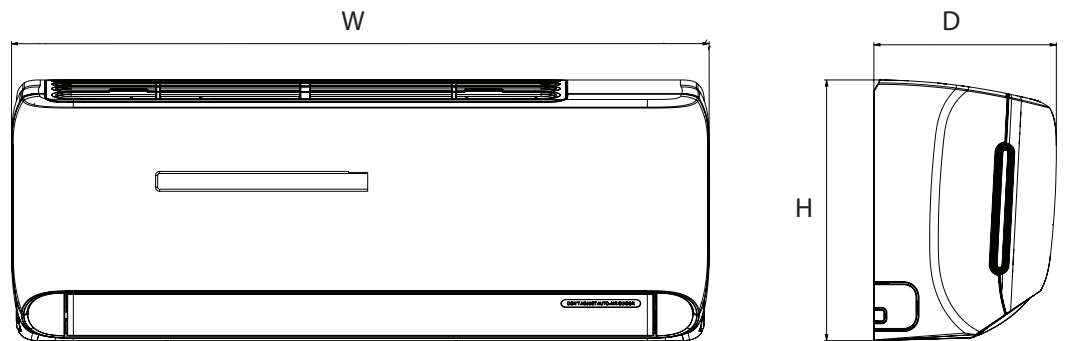

MOUNTING PLATE

Dimensions (inches)	
W1	13-25/32
W2	29-3/8
W3	10

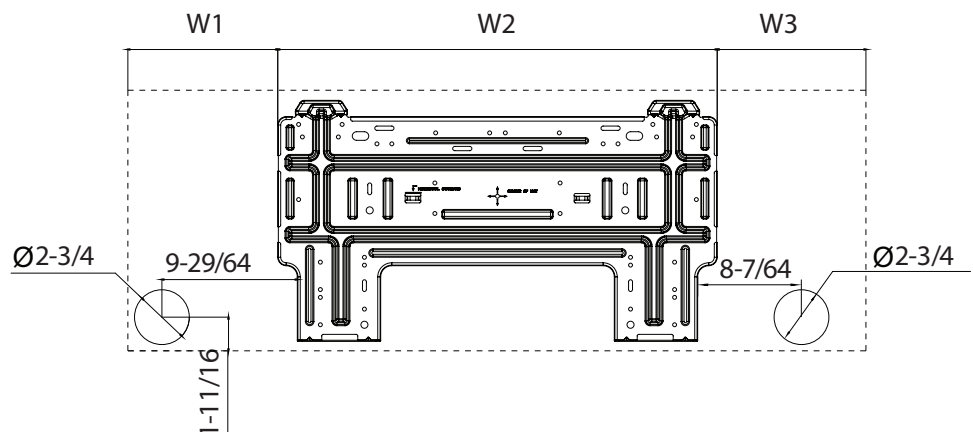



FEATURES & FUNCTIONS

SYSTEM FEATURES	
Inverter Type	G10
Ultra Low Frequency Torque Control	Yes
Power Factor Correction	Yes
Compressor Type	High Efficiency Rotary
Refrigerant Type	R410A
Basepan With Electric Heater	Yes
Compressor With Electric Heater	Yes
Outdoor Fin Coating (Color:Blue)	Acrylic-Resin/Anti-Corrosive
Intelligent Defrosting	Yes
Force Defrosting	Yes
Intelligent Preheating	Yes
Low Voltage Startup	Yes
Memory/Power Failure Recovery	Yes
Self Diagnosis	Yes
Wired Controller Interface (XE71)	Yes
WiFi Included	Yes
Indoor Fan Type	Crossflow
Multi Fan Speeds	4 Speeds
Indoor Unit Display	Yes
Auxiliary Electrical Heater	No
Ventilation (Outdoor Air)	No

REMOTE CONTROLLER FUNCTIONS	
Auto Mode	Yes
Auto Fan	Yes
Manual Horizontal Swing	Yes
Auto Swing (Vertical Auto Swing)	Yes
Clock on Remote Controller	Yes
Dry Mode	Yes
Dry Anti-Mildew (X-Fan) Mode	Yes
Energy Saving Mode	Yes
Dirty Filter Alert	No
I Feel Function	Yes
Lock on Remote Controller	Yes
Quiet Mode	No
Room Temperature Display	Yes
Sleep Mode	Yes
Timer Mode	Yes
Turbo Mode	Yes
Display On/Off Control	Yes
Freeze Guard Mode (46°F)	Yes
Display On/Off Control	Yes

FEATURES

- 208-230/1/60 power input
- Quiet and efficient heating & cooling.
- LED display shows set temperature & operating modes.
- Motorized louver system quietly distributes air evenly
- "U-TOUCH" Remote Control.
- DC Inverter technology
- Wide working ambient temperature ranges
- Stylish design

YMGI Group
 601 Arrow Ln, O'Fallon, Missouri 63366
 Phone: 1-866-833-3138
 Fax: 1-866-377-3355
 ymgigroup.com

Sales Representative or Distributor:

CLEARANCES

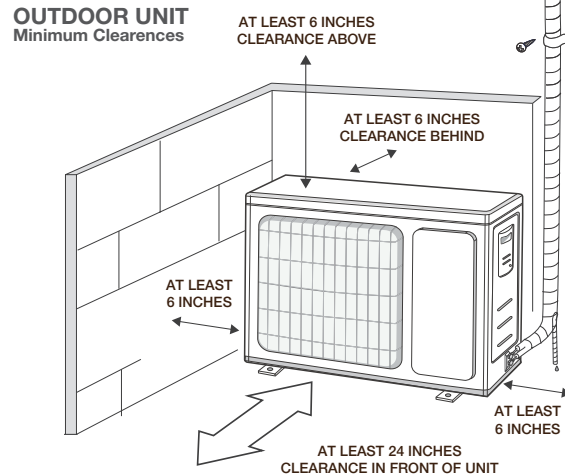
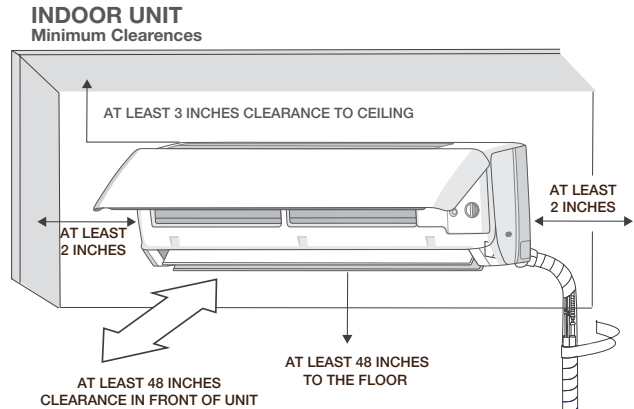

NOTE:
 If bottom of the unit is free of airflow obstructions as shown in the mounting bracket illustration, clearance to the wall on the back can be reduced to 3 inches.

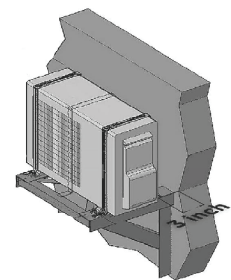

- Compact outdoor unit with side discharge
- Outdoor unit ships pre-charged.
- World-class quality compressors
- Durable powder coated cabinet
- Default flare brass connection valves
- Knock-outs for refrigerant pipes and wires
- Built to ETL/UL/CSA/ARI standards
- Easy installation and maintenance